

# SKN 141F



**Stud Diode**

## Fast Recovery Rectifier Diode

**SKN 141F**

**SKR 141F**

### Features

- Small recovered charge
- Soft recovery
- Hermetic metal case with glass insulator
- Threaded stud M12
- SKN: anode to stud;  
SKR: cathode to stud

### Typical Applications

- Inverse diode for GTO and asymmetric thyristor
- Inverters and choppers
- A.C. motor control
- Uninterruptible power supplies (UPS)

$V_{RSM}$ V	$V_{RRM}$ V	$I_{FRMS} = 260$ A (maximum value for continuous operation) $I_{FAV} = 140$ A (sin. 180; 1000 Hz; $T_c = 100$ °C)	
1200	1200	SKN 141F12	SKR 141F12
1400	1400	SKN 141F14	SKR 141F14
1500	1500	SKN 141F15	SKR 141F15
1700	1700	SKN 141F17	SKR 141F17

Symbol	Conditions	Values	Units
$I_{FAV}$	sin. 180; $T_c = 85$ (100) °C	168 (140)	A
$I_{FAV}$	K1,1F; $T_a = 35$ °C; sin. 180; 1000 Hz	114	A
$I_{FSM}$	$T_{vj} = 25$ °C; 10 ms	2500	A
	$T_{vj} = 150$ °C; 10 ms	2100	A
$i^2t$	$T_{vj} = 25$ °C; 8,3 ... 10 ms	31000	A <sup>2</sup> s
	$T_{vj} = 150$ °C; 8,3 ... 10 ms	22000	A <sup>2</sup> s
$V_F$	$T_{vj} = 25$ °C; $I_F = 300$ A	max. 1,8	V
$V_{(TO)}$	$T_{vj} = 150$ °C	max. 1,1	V
$r_T$	$T_{vj} = 150$ °C	max. 2	mΩ
$I_{RD}$	$T_{vj} = 25$ °C; $V_{RD} = V_{RRM}$	max. 1	mA
$I_{RD}$	$T_{vj} = 150$ °C; $V_{RD} = V_{RRM}$	max. 100	mA
$Q_{rr}$	$T_{vj} = 150$ °C; $I_F = 100$ A,	90	μC
$I_{RM}$	$-di/dt = 100$ A/μs, $V_R = 400$ V	90	A
$t_{rr}$		2000	ns
$E_{rr}$		-	mJ
$R_{th(j-c)}$		0,2	K/W
$R_{th(c-s)}$		0,08	K/W
$T_{vj}$		- 40 ... + 150	°C
$T_{stg}$		- 55 ... + 150	°C
$V_{isol}$		-	V~
$M_s$	to heatsink	10	Nm
$a$		5 * 9,81	m/s <sup>2</sup>
$m$	approx.	100	g
Case		E 31	

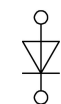

**SKN**

**SKR**

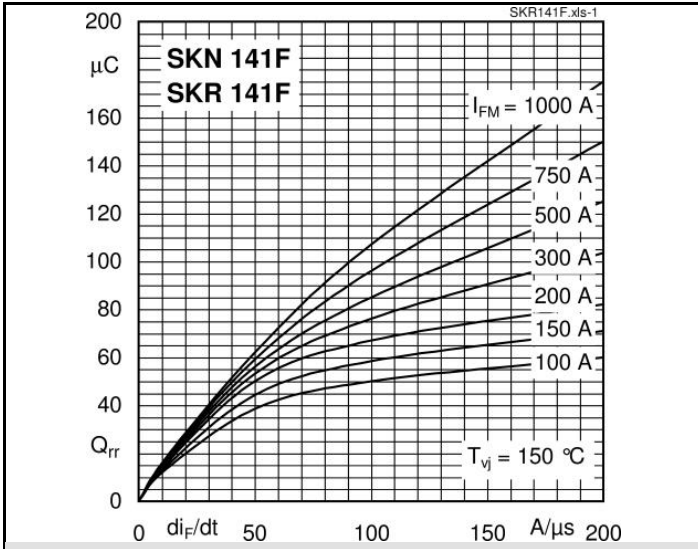

Fig. 1 Typ. recovery charge vs. current decrease

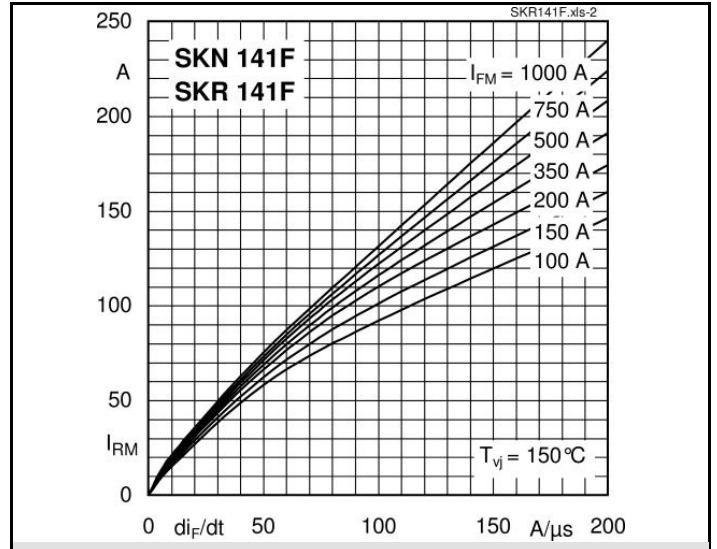

Fig. 2 Peak recovery current vs. current decrease

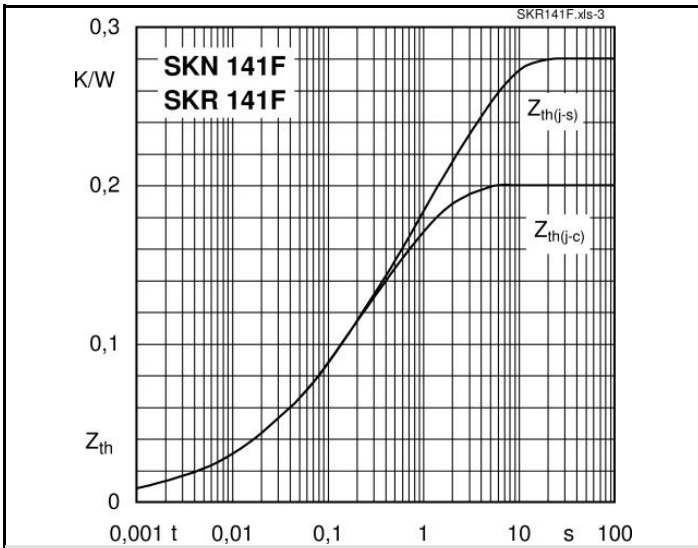

Fig. 3 Transient thermal impedance vs. time

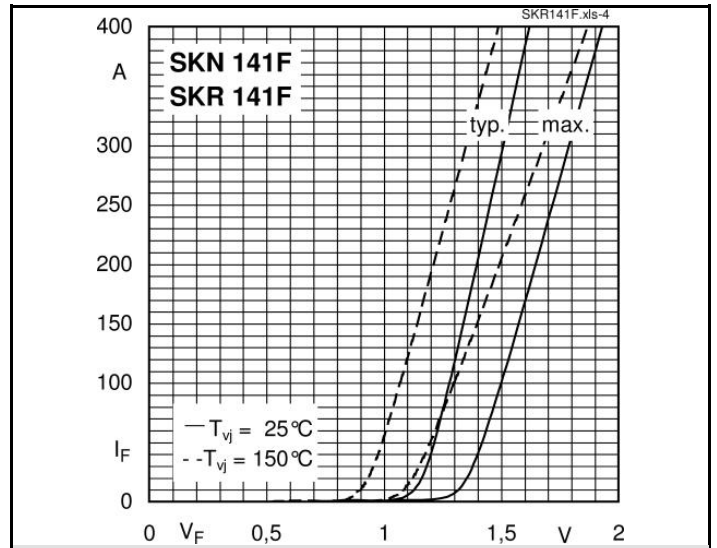

Fig. 4 Forward characteristics

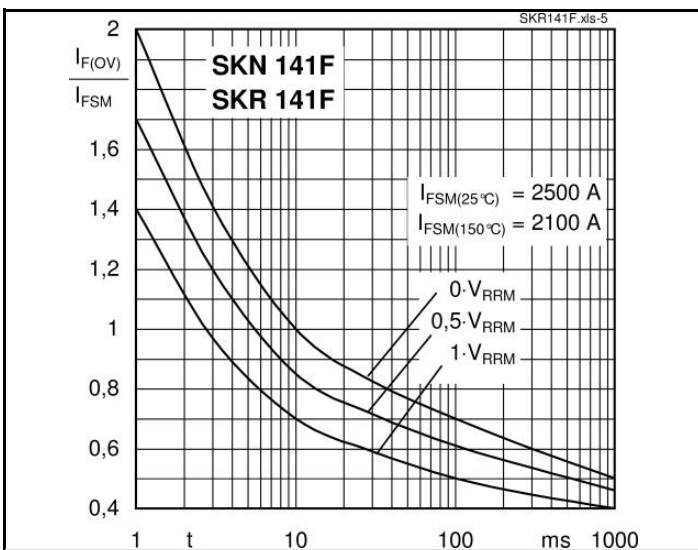
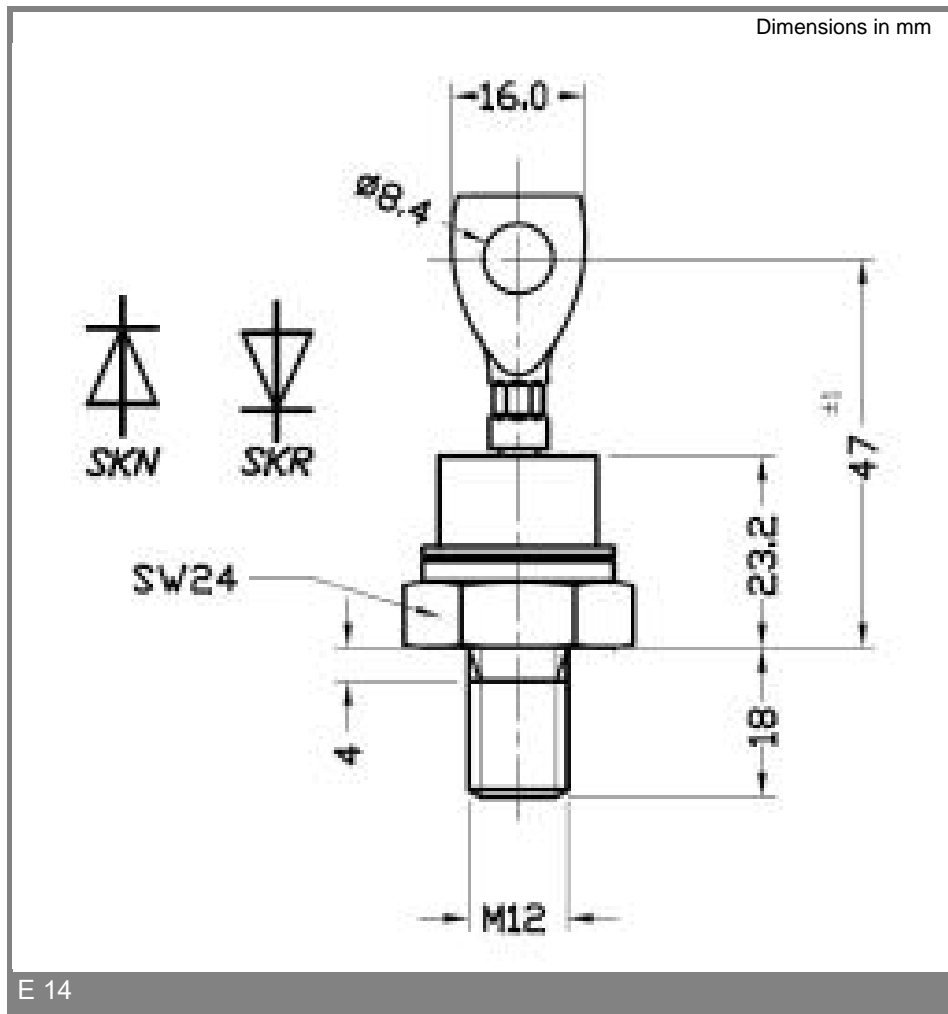

Fig. 5 Surge overload current vs. time



This technical information specifies semiconductor devices but promises no characteristics. No warranty or guarantee expressed or implied is made regarding delivery, performance or suitability.