

# SK 30 GB 123



SEMITOP<sup>®</sup> 2

## IGBT Module

SK 30 GB 123

SK 30 GAL 123

SK 30 GAR 123

Preliminary Data

### Features

- Compact design
- One screw mounting
- Heat transfer and isolation through direct copper bonding aluminium oxide ceramic (DBC)
- High short circuit capability
- N channel, homogeneous silicon structure (NPT= Non punch-through IGBT)
- Low tail current with low temperature dependance

### Typical Applications

- Switching (not for linear use)
- Inverter
- Switched mode power supplies
- UPS

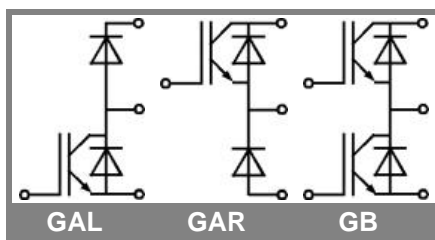

Absolute Maximum Ratings		$T_s = 25\text{ }^\circ\text{C}$ , unless otherwise specified	
Symbol	Conditions	Values	Units
<b>IGBT</b>			
$V_{CES}$		1200	V
$V_{GES}$		$\pm 20$	V
$I_C$	$T_s = 25\text{ (80) }^\circ\text{C}$ ;	33 (22)	A
$I_{CM}$	$t_p < 1\text{ ms}$ ; $T_s = 25\text{ (80) }^\circ\text{C}$ ;	66 (44)	A
$T_j$		- 40 ... + 150	$^\circ\text{C}$
<b>Inverse/Freewheeling CAL diode</b>			
$I_F$	$T_s = 25\text{ (80) }^\circ\text{C}$ ;	37 (25)	A
$I_{FM} = -I_{CM}$	$t_p < 1\text{ ms}$ ; $T_s = 25\text{ (80) }^\circ\text{C}$ ;	74 (50)	A
$T_j$		- 40 ... + 150	$^\circ\text{C}$
$T_{stg}$		- 40 ... + 125	$^\circ\text{C}$
$T_{sol}$	Terminals, 10 s	260	$^\circ\text{C}$
$V_{isol}$	AC 50 Hz, r.m.s. 1 min. / 1 s	2500 / 3000	V

Characteristics		$T_s = 25\text{ }^\circ\text{C}$ , unless otherwise specified			
Symbol	Conditions	min.	typ.	max.	Units
<b>IGBT</b>					
$V_{CE(sat)}$	$I_C = 25\text{ A}$ , $T_j = 25\text{ (125) }^\circ\text{C}$		2,5 (3,1)	3 (3,7)	V
$V_{GE(th)}$	$V_{CE} = V_{GE}$ ; $I_C = 0,001\text{ A}$	4,5	5,5	6,5	V
$C_{res}$	$V_{CE} = 25\text{ V}$ ; $V_{GE} = 0\text{ V}$ ; 1 MHz		1,65		nF
$R_{th(j-s)}$	per IGBT			1	K/W
	per module				K/W
$t_{d(on)}$	under following conditions: $V_{CC} = 600\text{ V}$ , $V_{GE} = \pm 15\text{ V}$		40		ns
$t_r$	$I_C = 25\text{ A}$ , $T_j = 125\text{ }^\circ\text{C}$		45		ns
$t_{d(off)}$	$R_{Gon} = R_{Goff} = 25\text{ }^\circ\Omega$		300		ns
$t_f$			45		ns
$E_{on} + E_{off}$	Inductive load		6,1		mJ
<b>Inverse/Freewheeling CAL diode</b>					
$V_F = V_{EC}$	$I_F = 25\text{ A}$ ; $T_j = 25\text{ (125) }^\circ\text{C}$		2 (1,8)	2,5 (2,3)	V
$V_{(TO)}$	$T_j = (125)\text{ }^\circ\text{C}$		(1)	(1,2)	V
$r_T$	$T_j = (125)\text{ }^\circ\text{C}$		(32)	(44)	m $\Omega$
$R_{th(j-s)}$				1,2	K/W
$I_{RRM}$	under following conditions: $I_F = 22\text{ A}$ ; $V_R = 600\text{ V}$		25		A
$Q_{rr}$	$di_F/dt = -500\text{ A}/\mu\text{s}$		4,5		$\mu\text{C}$
$E_{off}$	$V_{GE} = 0\text{ V}$ ; $T_j = 125\text{ }^\circ\text{C}$		1		mJ
<b>Mechanical data</b>					
M1	mounting torque			2	Nm
w			19		g
Case	SEMITOP <sup>®</sup> 2		T 8		

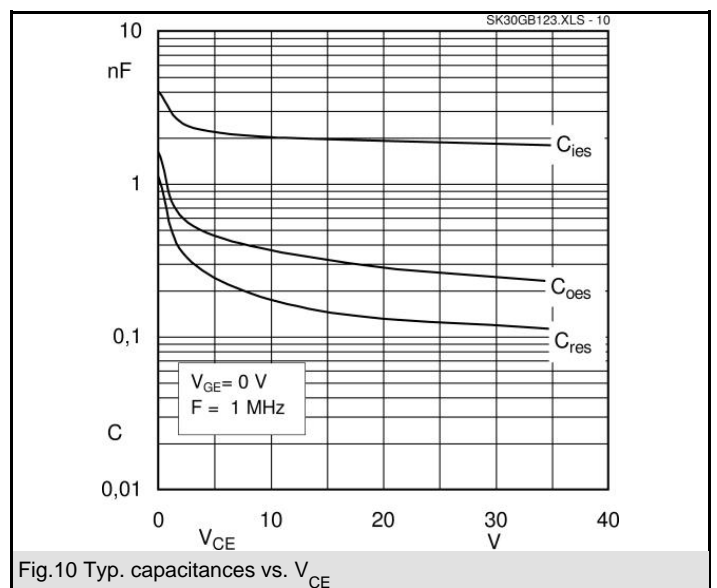
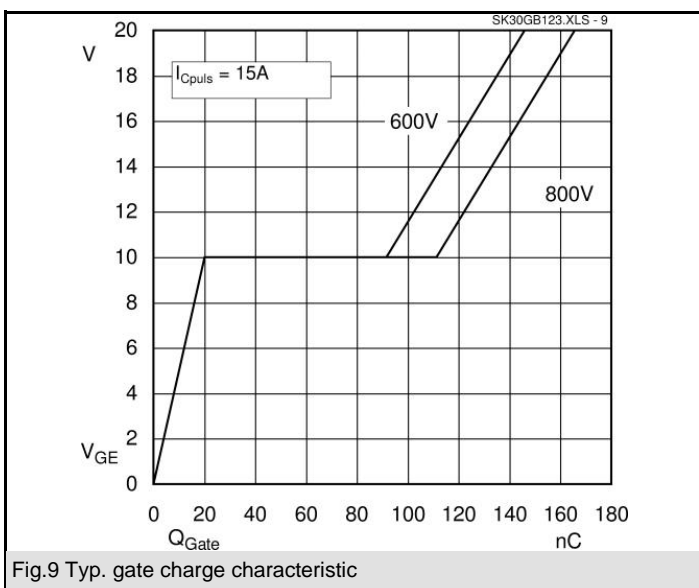
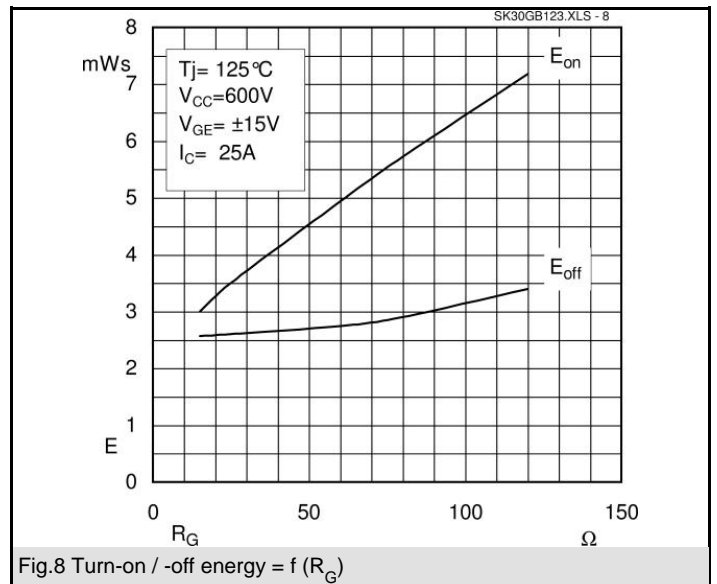
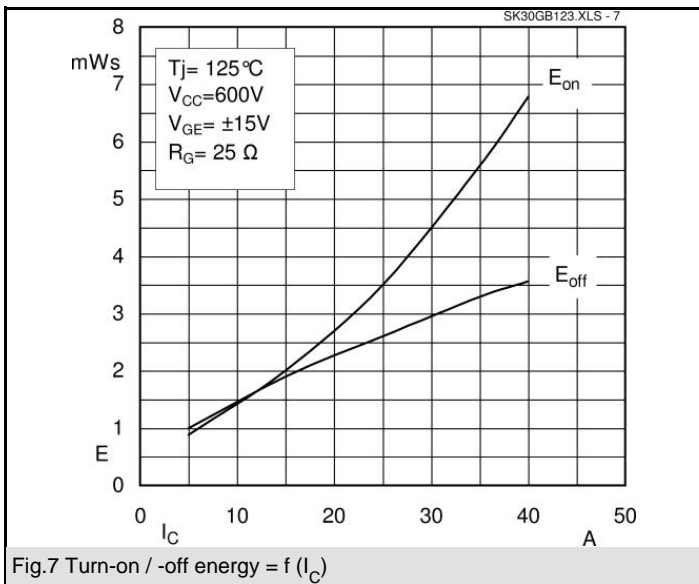
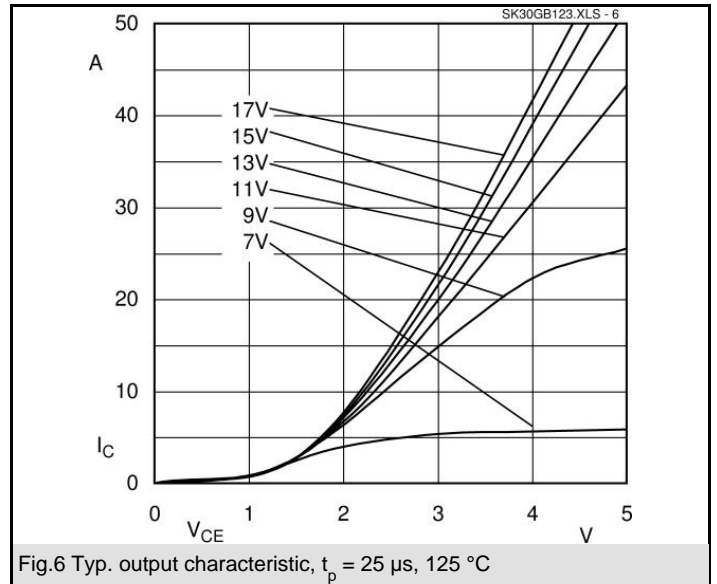
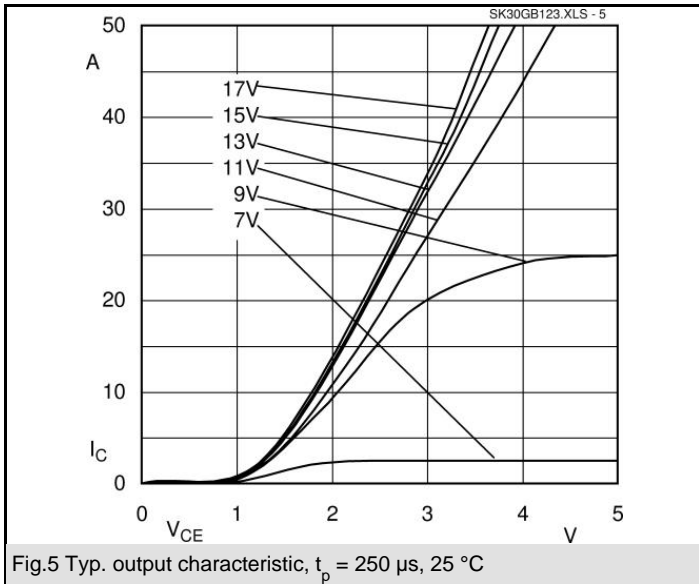

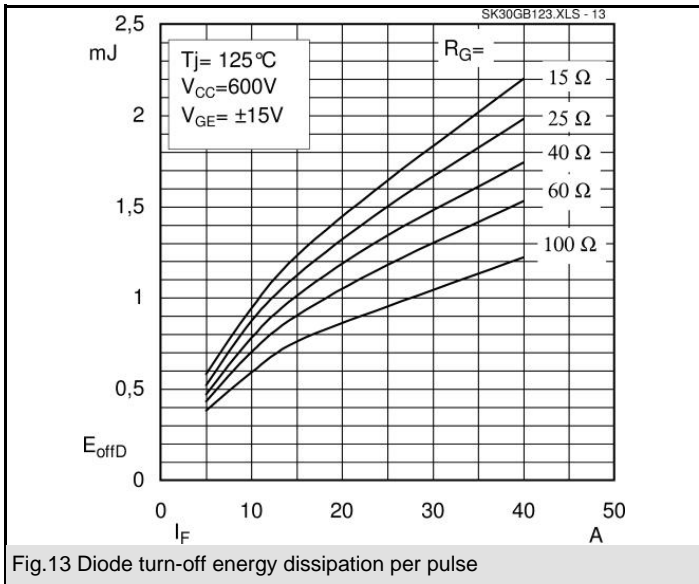
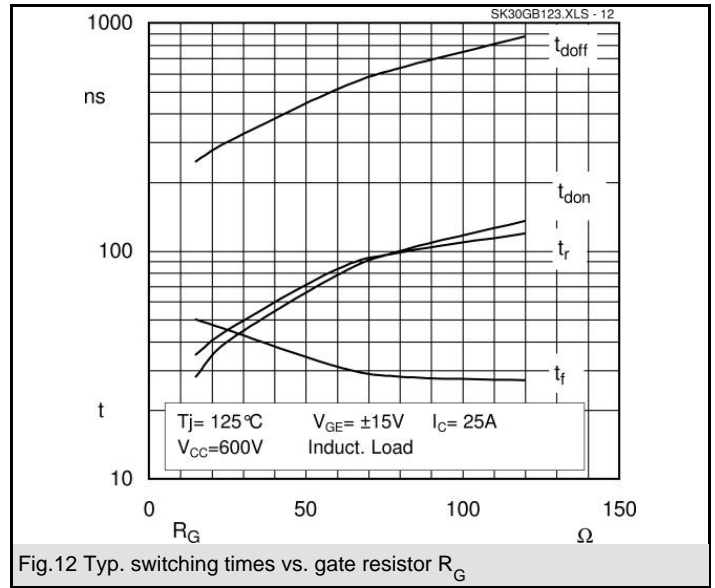
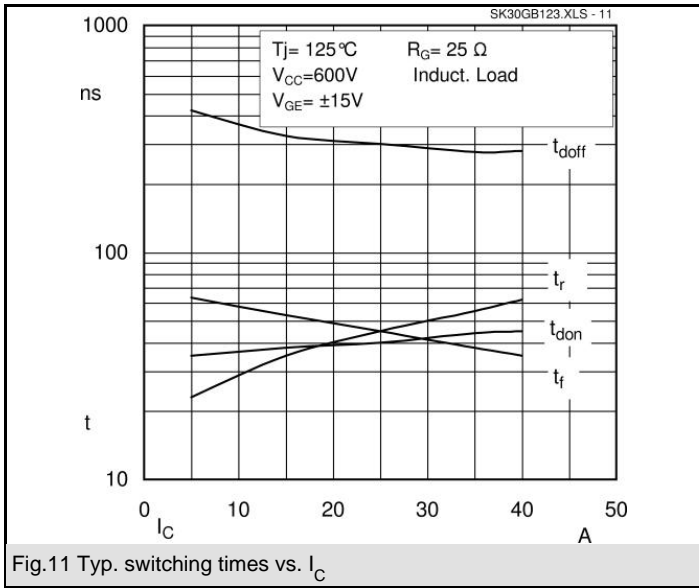

# SK 30 GB 123

UL Recognized  
File no. E 63532

Dimensions in mm

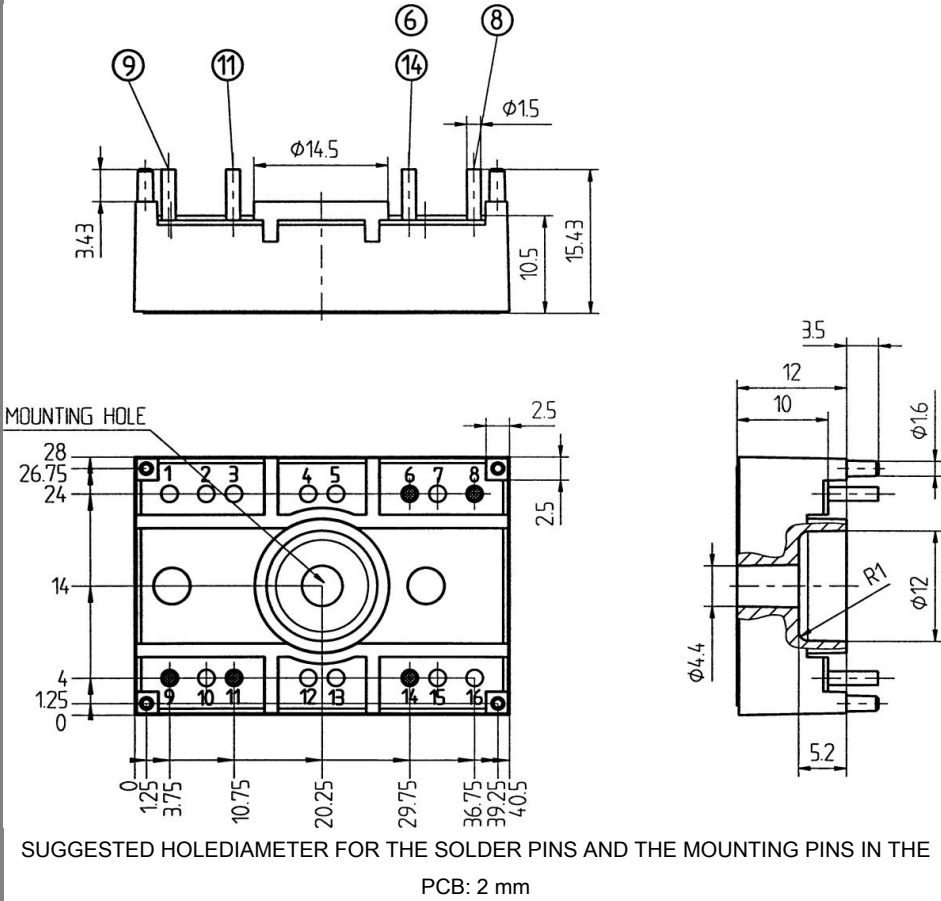

Case T8

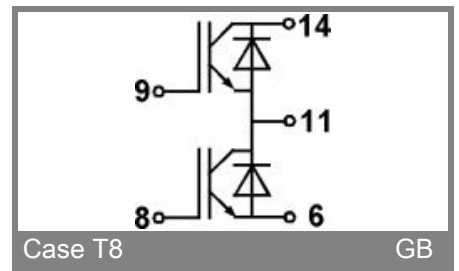
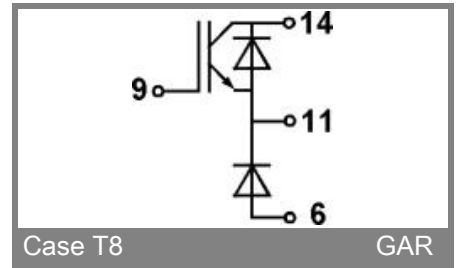
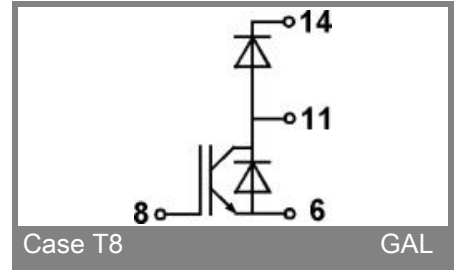

This is an electrostatic discharge sensitive device (ESDS), international standard IEC 60747-1, Chapter IX.

This technical information specifies semiconductor devices but promises no characteristics. No warranty or guarantee expressed or implied is made regarding delivery, performance or suitability.